

HVAC Insulation

U Protect Installation Manual

System for Fire-Resistant Duct Insulation



Content

1. ULTIMATE and U Protect – the standard for high performance	3
2. Rectangular duct insulation	7
2.1. Specifications for the wall / floor.....	7
2.2. Characteristics of ductwork prior to insulation installation.....	7
2.3. Choosing the insulation thickness.....	10
2.4. Choosing the pins and fire screws.....	10
2.5. Calculating the amount of glue and paint.....	12
2.6. Complete fire separation wall / floor penetrations.....	13
2.7. Fixation.....	14
2.8. Complete fire separation wall / floor penetrations.....	16
2.9. Fixation.....	17
2.10. Smoke extraction (according to EN 1366-8).....	18
2.11. Special cases.....	19
3. Circular duct insulation	21
3.1. Specifications for the wall / floor.....	21
3.2. Characteristics of rectangular ductwork prior to insulation installation.....	21
3.3. Choosing the insulation thickness.....	22
3.4. Calculating the length of wired mats	23
3.5. Calculating the amount of glue and paint.....	24
3.6. Complete fire separation wall / floor penetrations.....	25
3.7. Fixation	27
3.8. Smoke extraction (according to EN 1366-8)	28
3.9. Special cases	28
Appendix 1: Pin pattern.....	30
References.....	32

1. ULTIMATE and U Protect – the standard for high performance



What is ULTIMATE?

ULTIMATE results from more than 25 years of intense research carried out by ISOVER. ULTIMATE is produced thanks to a unique and patented fiberizing process, which ensures fine control of the fibre diameter. It results in a totally shot-free product, made of long interwoven fibres: a mineral wool with excellent fire protection properties, high flexibility and a drastically reduced weight when compared to traditional stone wool solutions.

U Protect solutions for HVAC

ISOVER has developed with U Protect a new innovative system for fire-resistant duct insulation in HVAC applications: The U Protect system does not only include high-performance ULTIMATE products but also all accessories necessary for efficient fire protection: intumescent paint, glue, screws, tape, pins & washers. Tested and certified to provide maximum safety and comfort during installation: The ISOVER U Protect system is the first one that is certified already according to the new **EN1366-1:2014** and **EN1366-8: 2004** standards.

U Protect in black



Aesthetics

U Protect, now faced with an innovative black facing gives good aesthetics, especially when installations are visible.



Easy to check

Black color enables to control that fire rated system has been installed on job-sites. Certified according to the latest version of the standard (EN 1366:2014).



Lightweight

U Protect weights up to 1/6 of conventional solutions.



Fire protection

U Protect meets the highest standard for fire protection: Non-combustible Euroclass A1.



Excellent fire resistance up to 2 hours solutions according to EN1366 – now also tested for smoke extracts!



Fast & cost efficient installation

ULTIMATE high resiliency makes cutting, bending or filling faster and more efficient than ever to insulate both air ducts and penetrations. It enables to benefit from time and material savings: one layer at penetration instead of two, no glue between joints.



Why should you use U Protect?



	Benefits	Features
	Certified system according to the latest EN standards	Fulfils EN 1366-1:2014 and EN 1366-8:2004
	Non-combustible system	Euroclass A1 fire rating
	Meets all thermal building regulations for higher energy savings	Low thermal conductivity: 0,031 W/m ² •K at 10°C mean temperature
	High-quality aesthetics	Innovation black facing: signature for fire protection
	Easy to check	
	Easy to handle, easy to carry	Up to 6 times lighter than conventional solutions
	Easy to cut	Standard insulation knife can be used for slabs
	Faster installation	Optimized dimensions for easy jobsite handling
	Cost saving	No glue between joints, only one layer at penetration
	Minimizes wastes on site	Off-cuts can be used
	No need for pre-fabrication	On-site installation possible
	Easy logistics, saves storage space	Compressed packaging

What do you need? – Product overview

U Protect Slabs



U Protect Slab 4.0
Slab: 1200 x 600 mm
Unfaced



U Protect Slab 4.0 Alu1
Slab: 1200 x 600 mm
Facing: black aluminium

U Protect Wired Mats



U Protect Wired Mat 4.0
Wired Mat: L x 600 mm
Unfaced

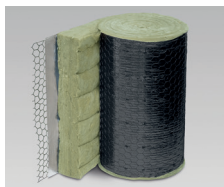

U Protect Wired Mat 4.0 Alu1
Wired Mat: L x 600 mm
Facing: black aluminium

Facings



Reinforced black aluminium foil

Protect Accessories



Isover Protect BSF
Solvent-free and pH-neutral, white, aqueous intumescent dispersion



Isover Protect BSK
Non-combustible, inorganic adhesive based on alkali sodium silicate

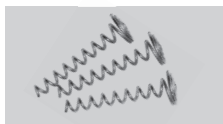

Isover FireProtect Screw
Spiral shaped screw made of galvanized steel



ISOVER Protect Black Tape
Self-adhesive aluminium tape

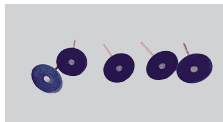

Pin with black washers
Provided by Climatex®

Dimensions and facings

Product Name			U Protect Slab 4.0		Product Name			U Protect Wired Mat 4.0	
Dimensions	Thickness (mm)		Length (m)	Width (mm)	Dimensions	Thickness (mm)		Length (m)	Width (mm)
		30	1.2	600			30	10.0	600
		40					7.5		
		50					6.0		
		60					5.0		
		70					4.3		
		80					4.0		
		90					3.7		
		90					3.3		
		100					3.0		
100	2.5								
Facing		None Glass tissue Black aluminium		Facing		None Glass tissue Black aluminium			

In some countries not all thicknesses will be commercially available. Please contact the local ISOVER team for specific installation details.



Key performances

Product Name		U Protect Slab 4.0	U Protect Wired Mat 4.0
Fire Reaction	Euroclass EN 13501	A1	
Thermal Properties	Declared Thermal Conductivity in mW/m.K EN ISO 13787	10 °C	31
		50 °C	35
		100 °C	40
		150 °C	47
		200 °C	54
		300 °C	72
		400 °C	96

Products are CE marked according EN 14303

2. Rectangular duct insulation

2.1. Specifications for the wall / floor

The wall/floor is a fire-rated construction.

The duct can penetrate:

All fire rated light-weight partitions equal to or greater than the resistance to fire of the ducts.

Construction	Wall / floor thickness (mm)	Wall / floor density (kg/m ³)
Rigid floor	≥ 150	> 575
Rigid wall	≥ 100 up to EI90	> 575
	≥ 150 for EI120	

2.2. Characteristics of rectangular ductwork prior to insulation installation

Duct sections



The duct section must be made of one folded steel sheet. Galvanized steel must be used with minimum thickness of 0,7mm according to EN 1366.

The ductwork must have an airtightness of minimum class B (i.e. classes C and D are accepted), according to EN 1507: 2006 in cold condition. The use of an inorganic chemistry based band between ducts' sections is required.

According to EN 1366-1, the maximum duct section is 1250 mm x 1000 mm. The maximum duct length is given by the following table:

Fire class	Maximum duct length (mm)
Up to EI90	1500
EI120	1250

Stiffeners

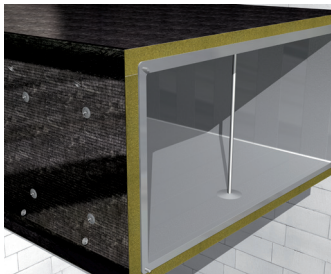

Stiffeners must be fitted perpendicularly to any side length that exceeds 500 mm. It should be positioned at midpoint in each duct section.

The stiffener must be:

- Either a steel pipe, minimum diameter 3/8" or 17.1 mm and thickness 2.3 mm. The steel pipe must be fixed to the ducts using 4 pieces of M70 washers with thickness 1 mm and minimum M6 bolts.
- Or a steel thread rod, minimum 8 mm diameter. It must be fixed to both sides of the duct section using 4 pieces of M70 washers with thickness 1 mm and minimum M8 nuts.

Steel flanges

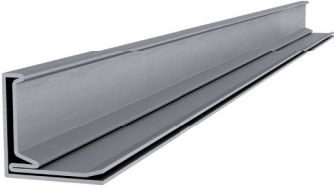

The duct sections shall be connected using steel flanges of minimum 30 x 30 mm and thickness 0.8 mm fixed to the duct using spot welding or steel screws at 150 mm centers. The flanges must not contain any grease.

Steel clamps



The flanges shall be held together using steel clamps (minimum M8 bolts) not exceeding the maximum distances stated in the below drawing.

The maximum distance between 2 clamps must be 265 mm. The maximum distance from the edge to the first clamp (see distance A on the picture) is given by the following table:

Duct width or height (mm)	Distance A (mm)
≤ 500	100
> 500	135

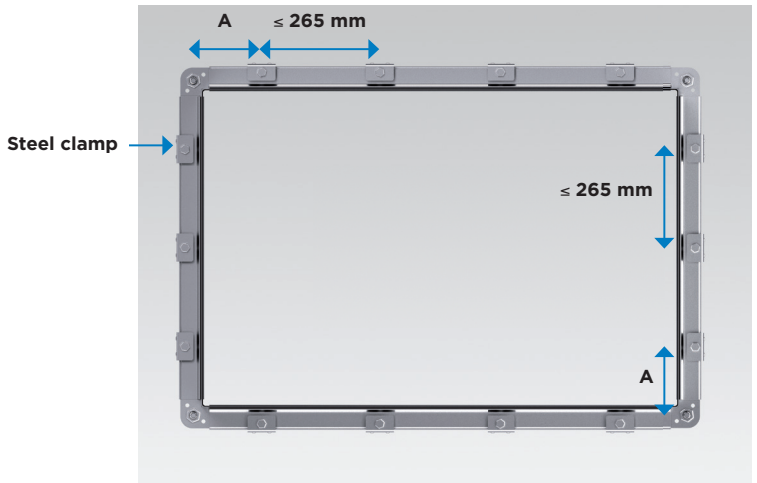

Suspension for horizontal ducts

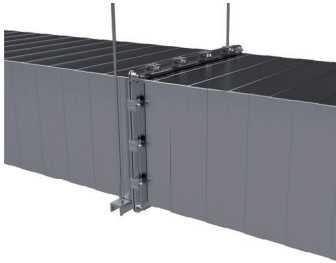

The duct should be suspended using steel rod hangers. The tension in the hangers in cold condition should not exceed:

- 9 N/mm² for resistance to fire equal to or lower than 60 minutes.

- 6 N/mm² for resistance to fire higher than 60 minutes.

The maximum distance between the suspensions should not exceed 1500 mm (1250 mm for EI120).

The horizontal suspension profile should not be positioned outside the insulation.

The following table shows diameters of the threaded rod to be used in case of U Protect Slab 4.0, 80 mm thick (duct thickness of 0.7 mm, duct length 1250 mm) and for a tension not exceeding 6N/mm².

Example:

For a duct size of w 1000 mm x h 600 mm, use threaded rod with a diameter of 10 mm.

		Width of the duct (m)								
		0.20	0.30	0.40	0.50	0.60	0.70	0.80	0.90	1.00
Height of the duct (m)	0.20									
	0.30	6 mm								
	0.40				8 mm					
	0.50									
	0.60									
	0.70									
	0.80									
	0.90									
	1.00									
	1.10									
	1.20									

The following table shows diameters of the threaded rod to be used in case of U Protect Slab 4.0, 60 mm thick (duct thickness of 0.7 mm, duct length 1500 mm) and for a tension not exceeding 9N/mm².

Example:

For a duct size of w 1000 mm x h 600 mm, use threaded rod with a diameter of 8 mm.

		Width of the duct (m)								
		0.20	0.30	0.40	0.50	0.60	0.70	0.80	0.90	1.00
Height of the duct (m)	0.20									
	0.30									
	0.40	6 mm								
	0.50									
	0.60									
	0.70									
	0.80									
	0.90									
	1.00									
	1.10									
	1.20									10 mm

2.3. Choosing the insulation thickness

The insulated duct going through the wall / floor must provide the same or higher fire resistance as the wall / floor.

For rectangular ducts we recommend to use **U Protect Slab 4.0** (ve ho o<->i) with following thickness (mm):

Fire class				
EI15	EI30	EI60	EI90	EI120
40	50	80	90	100

Alternative method for rectangular ducts is to use **U Protect Wired Mat 4.0** (ve ho o<->i) with following thickness (mm):

Fire class		
EI15	EI30	EI60
40	60	100

2.4. Choosing the pins and fire screws



The insulation is fixed to the duct using stud-welded pins of minimum 2.7 mm diameter and spring steel washers, minimum 30 mm diameter. We advise you to choose a length of pin a bit longer than the insulation thickness (-3 mm longer).



Joints at the corners are secured with ISOVER FireProtect Screws, which are spiral shaped screws made of galvanized steel. Their length must be 2 times the insulation thickness.

Pins and fire screws for horizontal ducts with U Protect 4.0 Slab

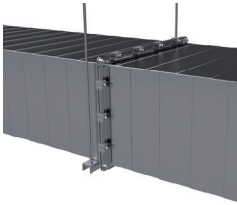

Number of pins / linear meter of duct (average)



Number of FireProtect Screws / linear meter of duct (average)

		Width of the duct (mm)				
		$w \leq 420$	$420 < w \leq 600$	$600 < w \leq 680$	$680 < w \leq 940$	$940 < w \leq 1200$
Height of the duct (mm)	$h \leq 420$	25 15	29 15	32 15	37 15	42 15
	$420 < h \leq (600\text{-thickness})$	33 15	38 15	40 15	45 15	50 15
	$(600\text{-thickness}) < h \leq 680$	39 17	43 17	45 17	50 17	55 17
	$680 < h \leq 940$	49 17	53 17	55 17	60 17	65 17
	$940 < h \leq 1000$	59 17	63 17	65 17	70 17	75 17

Pins and fire screws for vertical ducts with U Protect 4.0 Slab



Number of pins / linear meter of duct (average)



Number of FireProtect Screws / linear meter of duct (average)

		Width of the duct (mm)				
		$w \leq 420$	$420 < w \leq 600$	$600 < w \leq 680$	$680 < w \leq 940$	$940 < w \leq 1200$
Height of the duct (mm)	$h \leq 420$	34 17	42 17	47 17	57 17	67 17
	$420 < w \leq 680$	47 20	55 20	60 20	70 20	80 20
	$680 < h \leq 940$	57 20	65 20	70 20	80 20	90 20

Example: for a vertical ductwork of 10 m with a section of 1000 x 600, you will need to use $80 \times 10 = 800$ pins and $20 \times 10 = 200$ FireProtect Screws.

For fixation details, please refer to page 14

2.5. Calculating the amount of glue and paint

ISOVER Protect BSF intumescent paint

ISOVER Protect BSF must be used to seal the penetration. It is supplied in 15 kg buckets (11.6 l) or cartridges of 400g (310 ml). Coverage rates are given below per linear meter of joint in U Protect Slab, based on a thickness of 2 mm. On-site usage of paint will vary: these coverage rates should therefore be used for guidance purpose only. The opening is the distance between the duct and the wall/floor at penetration.



Size of the opening (mm)	Approximate weight (kg) of BSF paint per linear meter at penetration	Average number of penetrations (2 sides) that can be done with one bucket for a duct section of 600 x 1000 mm and an insulation thickness of 80 mm
20	0.05	44
30	0.08	29
40	0.10	22
50	0.13	17

ISOVER Protect BSK glue

ISOVER Protect BSK must only be used to glue the insulation products to the wall, floor or ceiling. It is supplied in 15 kg buckets (9.3 l) or cartridges of 500g (310 ml). Coverage rates are given below per linear meter of joint in U Protect Slab, based on an applied quantity of 0,66 g/cm². On-site usage of glue will vary: these coverage rates should therefore be used for guidance purpose only. The opening is the distance between the duct and the wall/floor at penetration.



Size of the opening (mm)	Approximate weight (kg) of BSK glue per linear meter at penetration	Average number of penetrations (2 sides) that can be done with one bucket for a duct section of 600 x 1000 mm
30	0.20	12
40	0.26	9
50	0.33	7
60	0.40	6
70	0.46	5
80	0.53	4
90	0.59	4
100	0.66	3

To calculate how much paint and glue is required

1. Calculate the total length of the penetration (2 sides of the wall/floor):
For BSF: $2 \times [(2 \times \text{width of duct}) + 2 \times (\text{height of duct} + 2 \times \text{size of the opening})]$ with all values in meters.
For BSK: $2 \times [(2 \times \text{width of duct}) + 2 \times (\text{height of duct} + 2 \times \text{insulation thickness})]$ with all values in meters
2. Read in previous tables the weight per linear meter corresponding to your configuration.
3. Multiply the 2 values obtained in 1. and 2.: this is the total paint/glue required!

2.6. Complete fire separation wall / floor penetrations

The same principle of installation is used for both horizontal and vertical ducts as well as for masonry and light-weight partition walls. This installation is done in 6 steps.

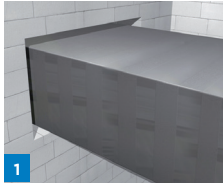

Step 1: Positioning

The duct is placed in the opening of the construction. The distance between duct wall and opening has to be ≤ 50 mm. The duct should have an internal support rod placed where the duct passes the construction.

For light-weight partition walls: the wall opening should be reinforced with a metal frame using same or similar profile as use for wall studs. Frame is installed on all four sides.

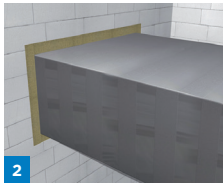
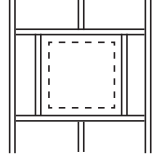

Step 2: Insulation of the penetration

Fill the space between duct and construction with the insulation board (it should be slightly compressed to completely fill the opening).



Step 3: Sealing

Seal the penetration with Isover Protect BSF to prevent leakages. This must be done on both sides of the construction. Use a spatula to apply a layer of ~ 2 mm thickness.



Step 4: Reinforcing the duct

Frame the duct by fixing an L-profile (30 x 30 x 3 mm) around it (see picture 4). The L-profile is fixed to the duct with steel rivets (3.2 x 10 mm) at 100 mm centers. The top and bottom profiles are fixed to the construction with four wall anchors each. The profiles need to be installed on both sides of the construction in horizontal installation. **For rigid floors,** in case of vertical insulation, profiles are only needed on the upper side.



Step 5: Duct insulation

Install the insulation slabs so that they stick to the construction. To avoid leakage caused by elongation of the steel in case of fire, the first slabs need to be glued to the construction using Isover Protect BSK (thickness ~ 2 mm).

For the slabs fixation with pins and fire screws, please refer to fixation part page 14.



Step 6: Completion

Use ISOVER Protect Black Tape to cover the slabs' edges. All joints are secured by pressing the slabs together.



To see the video of installation:
<http://www.isover-technical-insulation.com/hvac/applications/fire-resistant-ducts>

2.7. Fixation

Welded pins and washers are used to fix the insulation to the duct. Corner joints are secured with ISOVER FireProtect Screws. To know how many pins and fire screws you need for the installation, please refer to page 11.

ISOVER Slabs, FireProtect Screws and Pin pattern

Use 2 simple rules whatever the duct orientation is:

- Distance of the pins to the duct's edges or slab joints: 80 mm
- Maximum distance between pins: 260 mm

For more details, refer to page 28 - 29

Horizontal duct

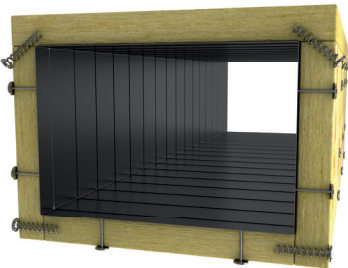

No pins are needed to fix the top slabs.

Vertical duct

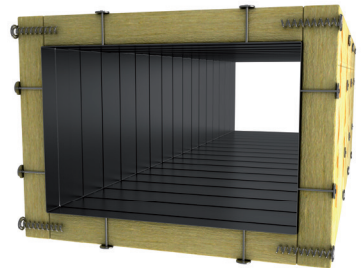

Top boards overlapping side boards overlapping downside boards!

Horizontal duct

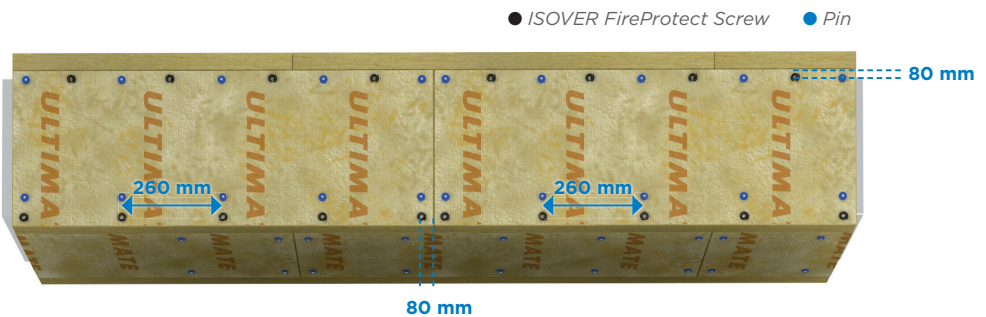

All joints are secured by pressing the slabs together **(no additional glue needed)**.

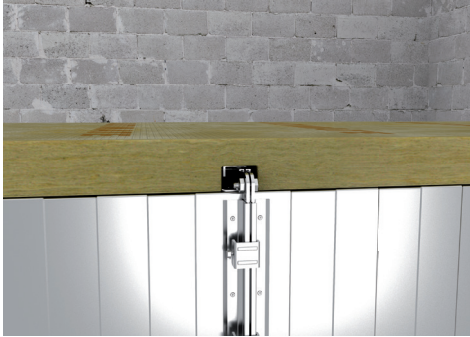

At duct flanges, the slabs need to be cut to fit the duct as tightly as possible. There is no thickness increase or double layer necessary on flanges for insulation thicknesses > 50 mm.

Cutting for a duct joint

For insulation thicknesses ≤ 50 mm, a 30 mm collar with width 120 mm must be added on top of the duct joints to cover the flanges.



For details on the pin pattern, see the following pictures:



Horizontal



Vertical

2.8. Complete fire separation wall / floor penetrations

The same principle of installation is used for both horizontal and vertical ducts as well as for masonry and light-weight partition walls. This installation is done in 6 steps.

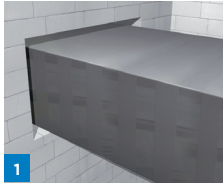

Step 1: Positioning

The duct is placed in the opening of the construction. The distance between duct wall and opening has to be ≤ 50 mm. The duct should have an internal support rod placed where the duct passes the construction.

For light-weight partition walls: the wall opening should be reinforced with a metal frame using same or similar profile as use for wall studs. Frame is installed on all four sides.

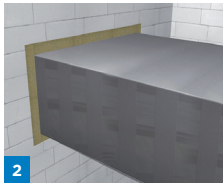
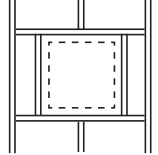

Step 2: Insulation of the penetration

Fill the space between duct and construction with the insulation from wired mat (it should be slightly compressed to completely fill the opening).



Step 3: Sealing

Seal the penetration with Isover Protect BSF to prevent leakages. This must be done on both sides of the construction. Use a spatula to apply a layer of ~ 2 mm thickness.



Step 4: Reinforcing the duct

Frame the duct by fixing an L-profile (30 x 30 x 3 mm) around it (see picture 4). The L-profile is fixed to the duct with steel rivets (3.2 x 10 mm) at 100 mm centers. The top and bottom profiles are fixed to the construction with four wall anchors each. The profiles need to be installed on both sides of the construction in horizontal installation. **For rigid floors,** in case of vertical insulation, profiles are only needed on the upper side.

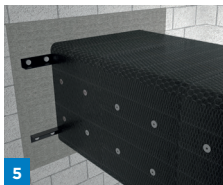

Step 5: Duct insulation

Install the insulation wire mat so that they stick to the construction. To avoid leakage caused by elongation of the steel in case of fire, the first wired mat need to be glued to the construction using Isover Protect BSK (thickness ~ 2 mm). For the wired mat fixation, please refer to page 27.



To see the video of installation:
<http://www.isover-technical-insulation.com/hvac/applications/fire-resistant-ducts>

2.9. Fixation

Welded pins and washers are used to fix the insulation to the duct.

ISOVER Wired Mat Pin pattern

Use 2 simple rules whatever the duct orientation is:

- Distance of the pins to the duct's edges or wired mat joints: 150 mm
- Maximum distance between pins: 300 mm

For more details, refer to page 30 - 31

Horizontal duct

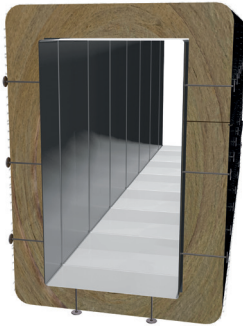

No pins are needed to fix the top wired mats.

Vertical duct

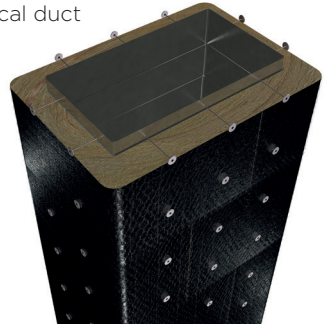

Fix the wired net mat refer to page 27.

Horizontal duct

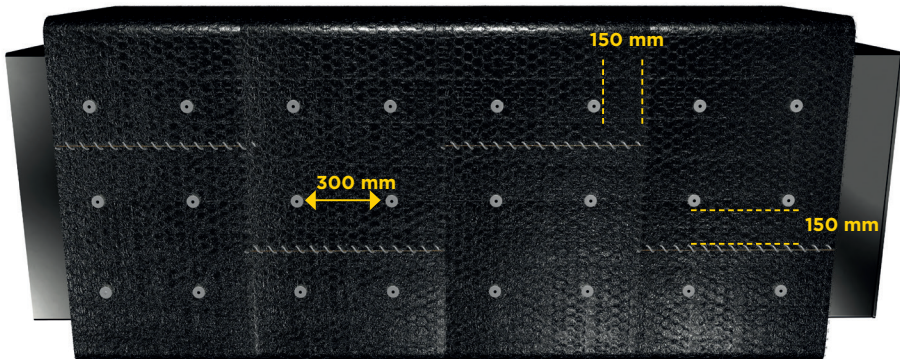

2.10. Smoke Extraction (according to EN 1366-8)

Stiffeners must be used and fitted perpendicular to any side of the duct where dimension exceeds 500 mm. One stiffener per every 0.3 [m²] surface of the duct side is needed.

The stiffeners must be:

- Either a steel thread rod diameter 8 mm, inside a 3/8" diameter steel pipe or steel pipe diameter 17.1 mm, thickness 2.3 mm.
- Or a stiffener made of steel with an equal stiffness as described above.

The steel rod must be fixed to the ducts using 4 pieces of M70 mm washers with thickness 1 mm and M8 nuts.

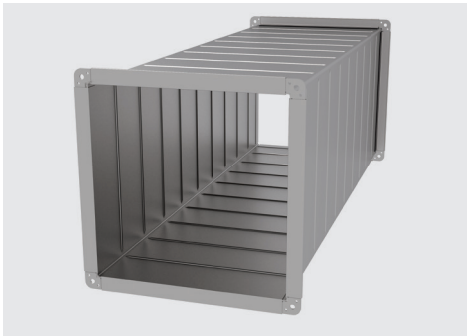

Examples:

Duct with width 500 mm, height 500 mm and section length 1500 mm: no stiffener needed.

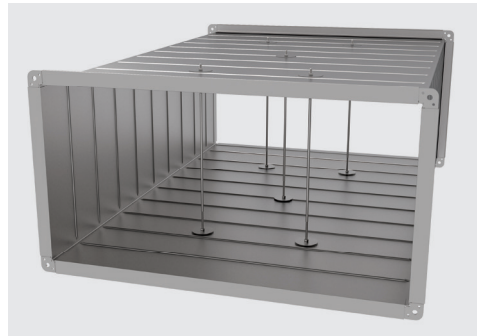

Duct with width 1000 mm, height 500 mm and section length 1500 mm: 5 stiffeners needed, evenly distributed over the surface.

The number of stiffeners to apply is: $(1 \times 1.5) \text{ [m}^2\text{]} / 0.3 \text{ [m}^2\text{/stiffener]} = 5 \text{ stiffeners.}$

Up to EI90, the minimum steel thickness is 0.7 mm.

For EI120, the minimum steel thickness is 1 mm and C-profiles with minimum steel thickness of 1 mm must be used over the steel flanges, together with the clamps.



2.11. Special cases

A. Access hatch design

Inspection hatch

It is important to have a fire safe solution that can be easily removed and installed again:

- The access panel is made of steel.
- The access panel hatch is mechanically fixed in each end using steel hardware.
- The frame size of the access panel should not exceed 290 mm x 420 mm.
- The EPDM-sealing shall be removed.

The insulation covering the access panel shall be fixed as on the picture.



B. 2 and 3-sided duct insulation

This solution can be used if the gap between duct and the closest wall/floor is lower than 300 mm. The construction must be symmetrical to the penetration (both sides of the wall/floor).

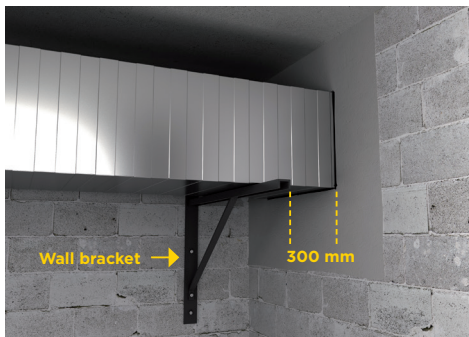

For a 2-sided installation: no need of L-profile. Use instead a wall bracket positioned 300 mm from the penetration, on both sides. It must be fixed using self-drilling steel screws at 300 mm centers.

Step 1: Positioning

The duct is placed in the opening of the construction. The hangers are positioned as for the classical solution.

Step 2: Sealing

Close the opening with mortar with a minimum density of 575 kg/m³ (see the below picture).

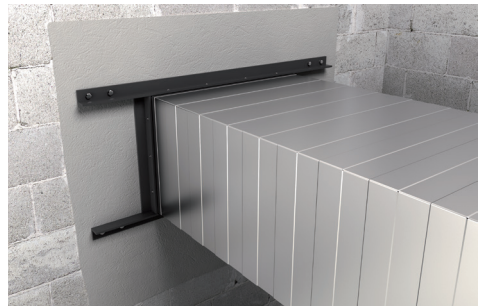

For a 3-sided installation: frame the duct by fixing an L-profile (30x30x3 mm) around it. The L-profile is fixed to the duct with steel rivets (3.2x10 mm) at 100 mm centers. The top and bottom profiles are fixed to the construction with 4 wall anchors each. The profiles need to be installed on both sides of the construction in horizontal installations. In case of vertical installations profiles are only needed on the upper side.

Step 3: Duct insulation

a. Position collars of insulation at the penetration (2 for a 2-sided duct insulation, only one for a 3-sided) and glue them to the duct using Protect BSK. The height of the collar should be minimum 60 mm and the width should be minimum 100 mm.



b. The duct insulation is mounted on the duct on the free sides. The slabs must be in contact with the floor/wall. The slabs in contact with the penetration must be glued to the mortar using ISOVER Protect BSK (see yellow arrow). Pins and fire screws are positioned according to classical pin pattern.

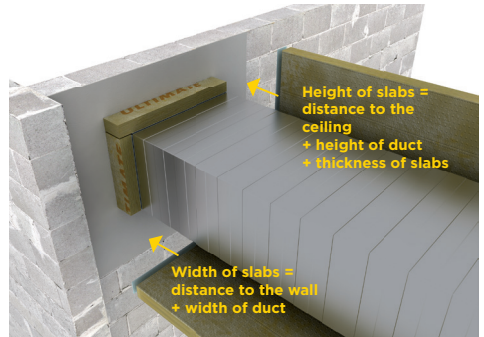

c. A collar with a minimum width of 60 mm and minimum height 100 mm should be positioned next to the duct insulation, and only glued to the surface of the floor/wall. A pin or a fire screw can help to hold this collar in place during the glue drying, but it must be removed afterwards.

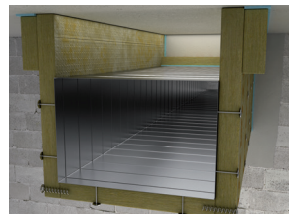
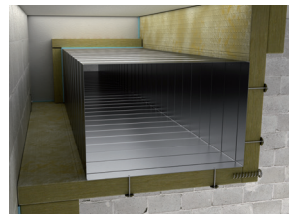
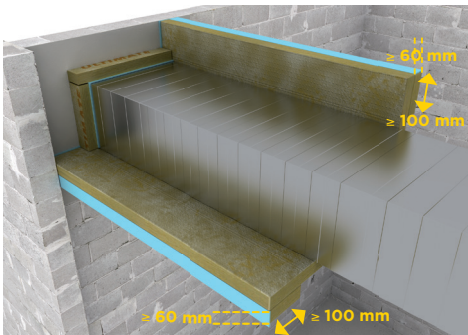

Pins and fire screws are positioned according to classical pin pattern.

3. Circular duct insulation

3.1. Specifications for the wall / floor

The wall/floor is a fire-rated construction.

The duct can penetrate:

All fire rated light-weight partitions are covered.

Construction	Wall / floor thickness (mm)	Wall / floor density (kg/m ³)
Rigid floor	≥ 150	> 575
Rigid wall	≥ 100 up to EI90	> 575
	≥ 150 for EI120	

3.2. Characteristics of circular ductwork prior to insulation installation

Duct sections

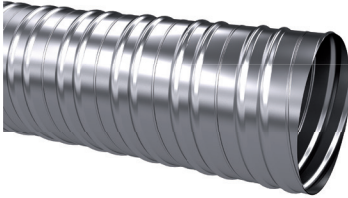

The circular duct sections must be made of at least 0.7 mm spiral folded steel sheet. It should be galvanised steel. The ductwork must have a tightness class D according to EN12237. According to EN 1366-1, the maximum diameter of the steel duct is 1000 mm.

Connections

The circular duct sections must be connected using steel nipples. The nipple should in both ends be fitted with a sealing strip of EPDM-rubber and a 20 x 3 mm inorganic chemistry based band. The duct sections should be fixed to the nipples using self tapping screws at 150 mm centres.

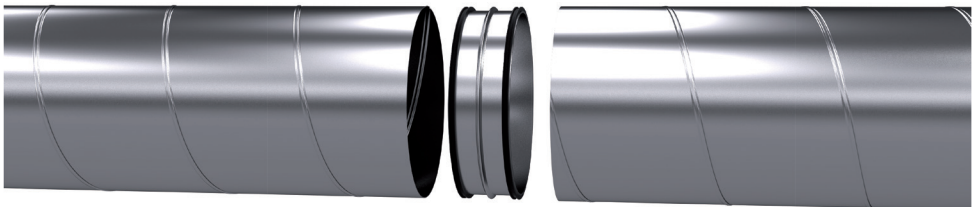

EI120

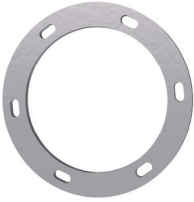

Steel ducts used for EI120 shall be fitted with 40 x 5 mm flat bar flanges positioned midway between the hangers (at 1200mm centers).

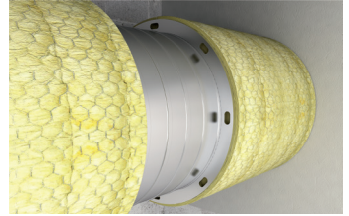

Suspension for horizontal ducts

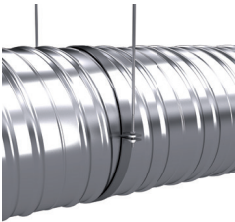

The horizontal circular ducts should be suspended using steel rod hangers. The tension in the hangers in cold condition should not exceed 9 N/mm² for resistance to fire equal to or lower than 60 minutes and 6 N/mm² for resistance to fire higher than 60 minutes. The maximum distance between the suspensions should not exceed 1500 mm. The suspension rods should be fixed to the steel duct using profiles made from 2 x 25 mm galvanized steel plates.

		Duct's Ø (mm)										
		100	125	160	200	250	315	400	500	630	800	1000
Hangers Ø (mm)	5											
	6											
8												
10												
10												

The table above shows diameters of the threaded rod to be used in case of U Protect Wired Mat 4.0, 120 mm thick (duct thickness of 0.7 mm, duct length 3000 mm) and for a tension not exceeding 6N/mm².

		Duct's Ø (mm)										
		100	125	160	200	250	315	400	500	630	800	1000
Hangers Ø (mm)	4											
	5											
6												
8												
8												
8												

The table above shows diameters of the threaded rod to be used in case of U Protect Wired Mat 4.0, 75 mm thick (duct thickness of 0.7 mm, duct length 3000 mm) and for a tension not exceeding 9N/mm².

3.3. Choosing the insulation thickness

The insulated duct going through the wall / floor must provide the same fire resistance as the wall / floor. For rectangular ducts we recommend to use **U Protect Wire Mat 4.0** (ve ho o->) with following thickness (mm):

Fire class				
EI15	EI30	EI60	EI90	EI120
40	50	75 (80)	100	120 (125*)

Number in parenthesis means thickness in mm to use in case of light-weight partition walls.

* in two layers

3.4. Calculating the length of wired mats

To calculate the length of wired mats needed (in mm), the following formula can be used:

$$\text{Length} = (\text{diameter of the circular duct} + 2 \times \text{thickness of the wired mat}) \times 3.14$$

This is the theoretical length of the mat.

		Thickness of wired mats (mm)		
		90	100	120
Diameter of the circular duct (mm)	200	1200	1260	1390
	250	1360	1420	1540
	300	1510	1580	1700
	350	1670	1730	1860
	400	1830	1890	2020
	450	1980	2050	2170
	500	2140	2200	2330
	550	2300	2360	2490
	600	2450	2520	2640
	650	2610	2670	2800
	700	2770	2830	2960
	750	2930	2990	3110
	800	3080	3150	3270
	850	3240	3300	3430
	900	3400	3460	3590
	950	3550	3620	3740
1000	3710	3770	3900	

■ One wired mat
■ Two wired mats

Save time:

Add a distance of around 10 cm and cut the wool to have the wire mesh overlapping. It will be necessary for the fixation.

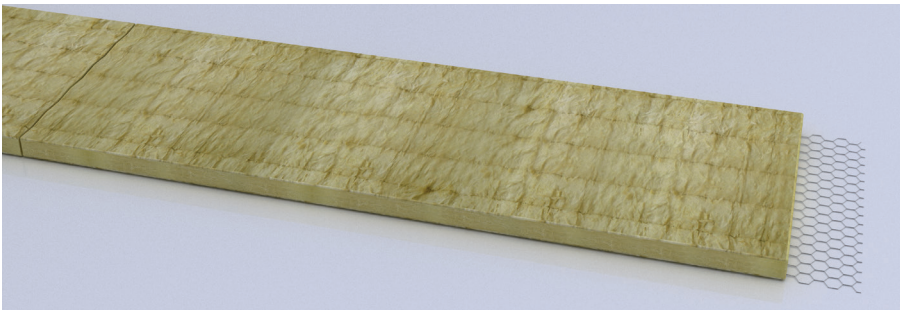

3.5. Calculating the amount of glue and paint

ISOVER Protect BSF intumescent paint

ISOVER Protect BSF must be used to seal the penetration. It is supplied in 15 kg buckets (11.6 l) or cartridges of 400g (310 ml). Coverage rates are given below per linear meter of joint in U Protect Wired Mat, based on a thickness of 2 mm. On-site usage of paint will vary: these coverage rates should therefore be used for guidance purpose only.

The opening is the distance between the duct and the wall/floor at penetration.



Size of the opening (mm)	Approximate weight (kg) of BSF paint per linear meter at penetration	Average number of penetrations (2 sides) that can be done with one bucket for a duct diameter of 1000 mm and an insulation thickness of 80 mm
20	0.05	44
30	0.08	29
40	0.10	22
50	0.13	17

ISOVER Protect BSK glue

ISOVER Protect BSK must only be used to glue the insulation products to the wall, floor or ceiling. It is supplied in 15 kg buckets (9.3 l) or cartridges of 500g (310 ml). Coverage rates are given below per linear meter of joint in U Protect Wired Mat, based on an applied quantity of 0,66 g/cm². On-site usage of glue will vary: these coverage rates should therefore be used for guidance purpose only. The opening is the distance between the duct and the wall/floor at penetration.



Size of the opening (mm)	Approximate weight (kg) of BSK glue per linear meter at penetration	Average number of penetrations (2 sides) that can be done with one bucket for a duct diameter of 1000 mm and an insulation thickness of 80 mm
30	0.20	11
40	0.26	8
50	0.33	7
60	0.40	6
70	0.46	5
80	0.53	4
90	0.59	4
100	0.66	3

To calculate how much paint and glue is required

1. Calculate the total length of the penetration (2 sides of the wall/floor):
For BSF: $2 \times [3.14 \times (\text{diameter of the duct} + \text{size of the opening})]$ with all values in meters.
For BSK: $2 \times [3.14 \times (\text{diameter of the duct} + \text{thickness of ULTIMATE})]$ with all values in meters
2. Read in previous tables the weight per linear meter corresponding to your configuration.
3. Multiply the 2 values obtained in 1. and 2.: this is the total paint/glue required!

3.6. Complete fire separation wall / floor penetrations

Simplified installation

for lower fire classes (EI15, EI30, EI60) with distance between duct and wall opening below 20 mm

The same principle of installation is used for both horizontal and vertical ducts for rigid walls. This simple installation is done in only 3 steps.

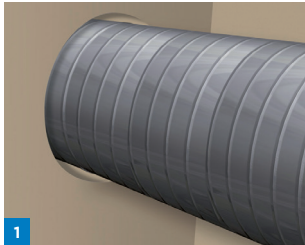

1

Step 1: Positioning

The duct is installed in the opening of the construction.

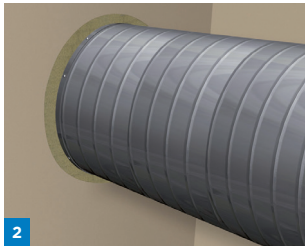

2

Step 2: Insulation of the penetration

Fill the space between duct and construction with the insulation mat (it should be compressed to completely fill the opening).

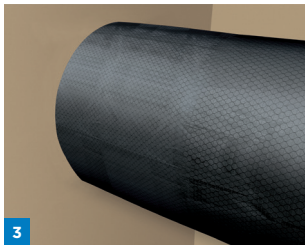

3

Step 3: Duct insulation

Install the insulation mats so that they abut the construction. To avoid leakage caused by elongation of the steel in case of fire, the wired mat needs to be glued to the construction using ISOVER Protect BSK (thickness - 2 mm).

To see the video of installation:
<http://www.isover-technical-insulation.com/hvac/applications/fire-resistant-ducts>



Standard installation

for all fire classes with distance between duct and wall opening below 50 mm

The same principle of installation is used for both horizontal and vertical ducts as well as for with masonry and lightweight partition walls. This installation is done in 5 steps.

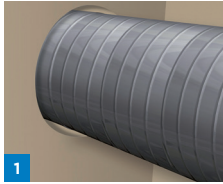

Step 1: Positioning

The duct is installed in the opening of the construction. For light-weight partition walls only; the wall opening should be reinforced with a metal frame using same profile or similar as used for wall studs. Frame is installed on all four sides (see sketch).

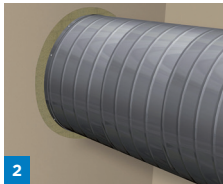
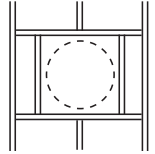

Step 2: Insulation of the penetration

Fill the space between duct and construction with the insulation mat (it should be compressed to completely fill the opening).

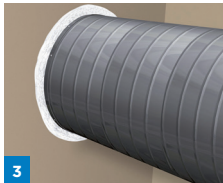

Step 3: Sealing

Seal the penetration with ISOVER Protect BSF to prevent leakages. This must be done on both sides of the construction. Use a spatula to apply a layer of - 2 mm thickness.

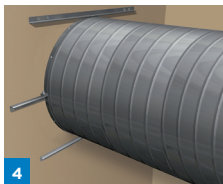

Step 4: Reinforcing the duct

A suspension bracket (30 x 2 mm) is screwed to the duct (at 150mm centers) on each side of the construction. Longer L-profiles (30 x 30x 3 mm) are fixed above and below the bracket with one rivet each (3.2 x 10 mm) and whereas short. L-profiles (30 x 30 x 3 mm) are fixed with nuts and bolts (M8) to the bracket eye. Fixation to the construction is done with wall anchors. The profiles need to be installed on both sides of the construction.

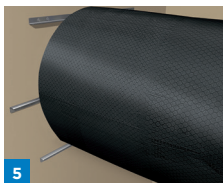

Step 5: Duct insulation

Install the insulation mats so that they stick to the construction. To avoid leakage caused by elongation of the steel in case of fire, the wired mat needs to be glued to the construction using ISOVER Protect BSK (thickness - 2 mm). For the wired mat fixation, please refer to the next page.



To see the video of installation:
[http://www.isover-technical-insulation.com/hvac/
 applications/fire-resistant-ducts](http://www.isover-technical-insulation.com/hvac/applications/fire-resistant-ducts)

3.7. Fixation

For both vertical and horizontal installations, the insulation mats do not need to be fixed with pins and fire screws. All joints are secured by pressing the mats together (no additional glue needed).

Two fixation methods can be used to close the joints between the wired mats:

C-Rings method

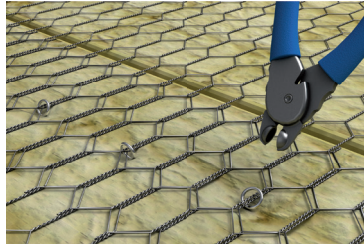
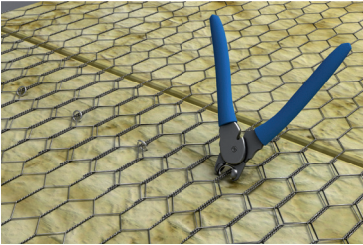

C-rings can be attached to fix the two parts of wired mesh together.

Hook tool method

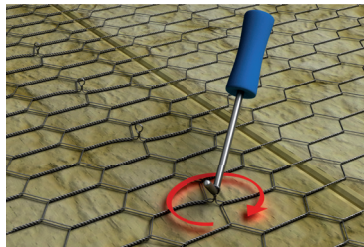
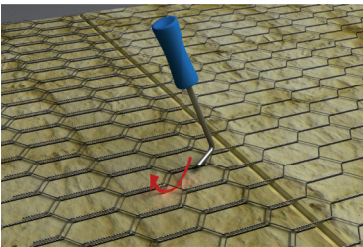

The wired net can be attached one to each other by use of a hook tool.

Detailed method:

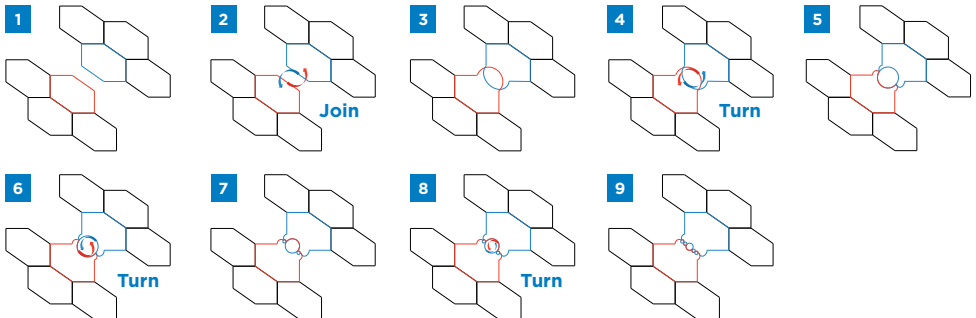

3.8. Smoke Extraction (according to EN 1366-8)

Simply add 40 x 5 mm flat bar flanges positioned midway between the hangers (at 1200mm centers). This solution is the same as EI120 for ventilation ducts (refer to page 20).

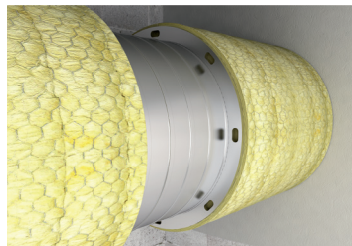

3.9. Special cases

Circular ducts installed close to walls and floors

This solution can be used if the gap between duct and wall / floor is lower than 200 mm.

The construction must be symmetrical to the penetration.

Step 1: Positioning

The duct is placed in the opening of the construction. The hangers are positioned as for the classical solution.

Step 2: Sealing

Close the opening with mortar with a minimum density of 575 kg/m³.

Step 3: Reinforcing the duct

If the duct has a diameter \leq 400 mm: there is no need to secure the duct with suspension profile and steel angles.



If the duct has a diameter > 400 mm:

The duct is fixed on both sides to the aperture wall using two sets of suspension profiles (2x25 mm) with steel angles (2x30x30 mm) fixed to the duct with self drilling screws (2 pieces, 4.2x25 mm - not screwed to the wall but only to the duct). These angles should be positioned at 400 mm centres, minimum 2.

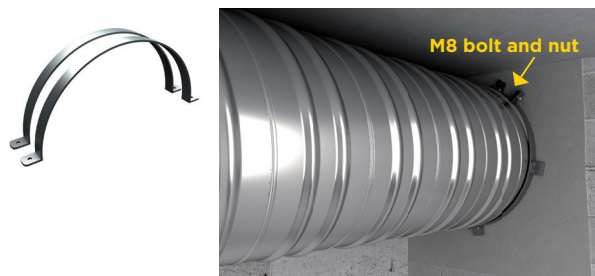

For the next step, there are 2 cases depending on the distance to the wall or floor:

Case a: Insulation thickness < distance D

The distance D from the wall or floor is lower than 200 mm but higher than the thickness of the insulation: with this distance it is possible to wrap entirely the insulation around the duct.

Step 4a: Duct insulation

Install the insulation mats so that they stick to the construction. The wired mat needs to be glued to the mortar using ISOVER Protect BSK (thickness ~ 2 mm).

The fixation is done according to the classical methods (see p.25)

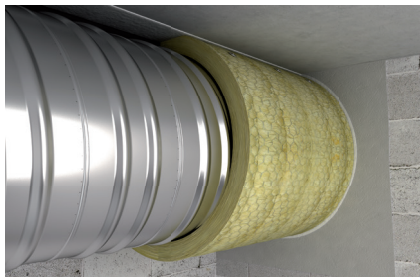

Case b: Insulation thickness > distance D

The distance D from the wall or floor is equal or lower than insulation thickness: it is impossible to wrap entirely the insulation around the duct.

Step 4b: Duct insulation

Install the insulation mats so that they stick to the construction. The wired mat needs to be glued to the mortar using ISOVER Protect BSK. Because the distance to the wall or floor doesn't allow to wrap the insulation all around the duct, the wired mat must be glued to the wall or floor with ISOVER Protect BSK according to the following drawing. The width of the glue band should be equal to minimum the thickness of the insulation.

The insulation should be fixed to the duct using steel welding pins (diameter 3 mm, washer 30 mm) positioned every 300 mm in the longitudinal direction of the duct, fixed as close as possible to the insulation edge.



Appendix 1: Pin pattern

Rectangular horizontal ducts with U Protect Slab 4.0

- Distance of the pins to the duct's edges or slab joints: 80mm
- Maximum distance between pins: 260mm

● ISOVER
FireProtect Screw

● Pin

w stands for duct width

l stands for duct length

h stands for duct height

Horizontal duct

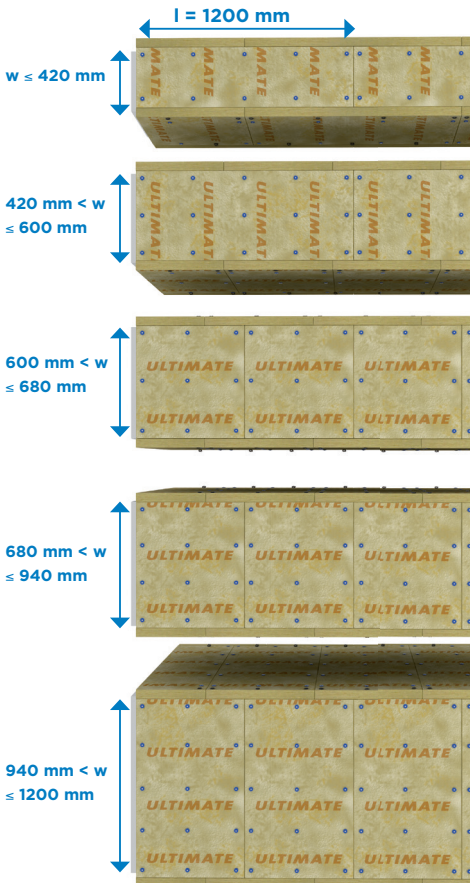

Side slabs

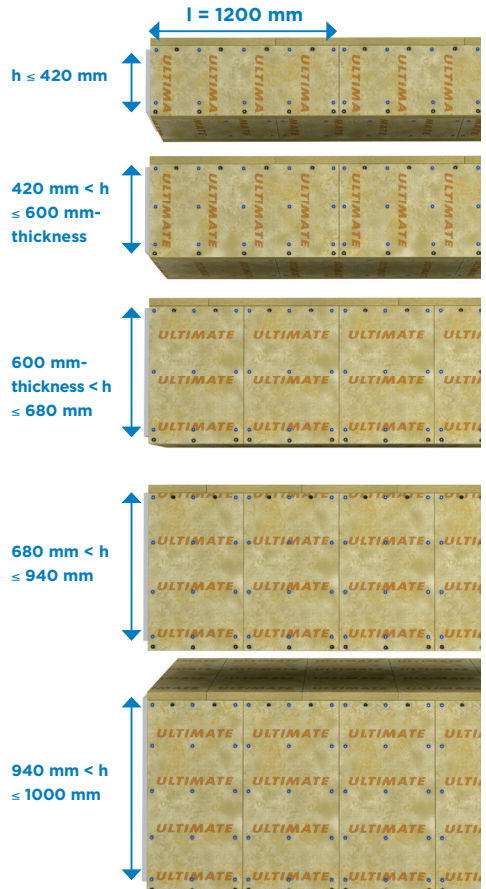

Rectangular vertical ducts with U Protect Slab 4.0

- Distance of the pins to the duct's edges or slab joints: 80mm
- Maximum distance between pins: 260mm

● ISOVER

FireProtect Screw

● Pin

w stands for duct width

l stands for duct length

Slabs with overlapping

$w \leq 420$ mm & slab thickness ≤ 90 mm or

$w \leq 400$ mm & slab thickness = 100 mm

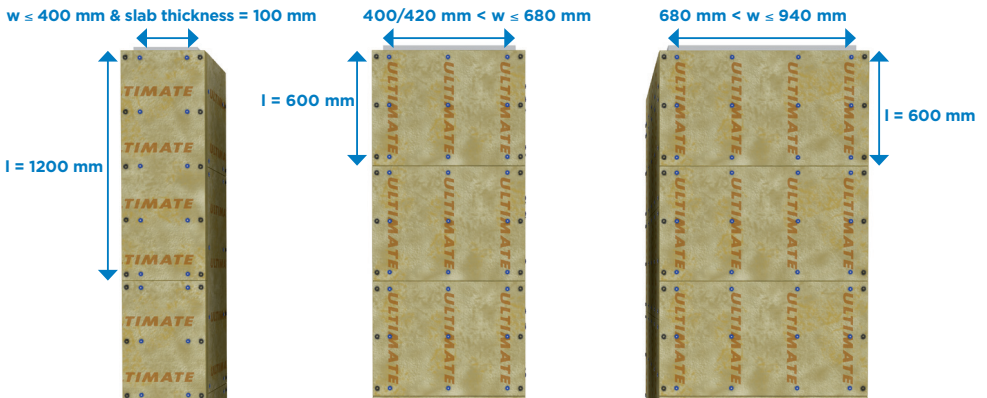

Slabs without overlapping

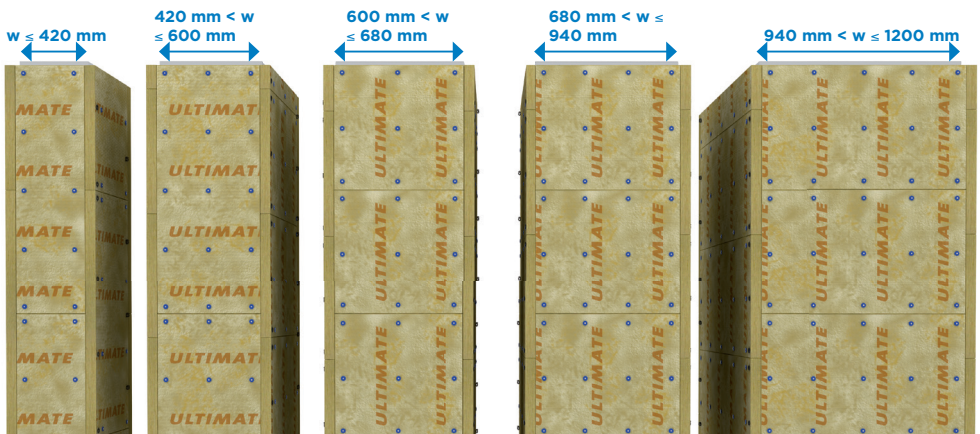

References

**More than 1 million square meters
already installed across Europe!**



*Kastelli community center
Finland, 2014*



*Business centre K29
Lithuania, 2015*



*Seguridad Social
Spain, 2012*



 **Easy Installation**

 **Easy Logistics**

 **Unique Lightness**

 **On-Site Flexibility**

 **Cost Effective Solution**

 **Easy to check**

 **Fast Installation**

 **Fire Protection**

 **Thermal Insulation**



Saint-Gobain ISOVER
„Les Miroirs“
18, avenue d'Alsace
92400 Courbevoie · France
www.ISOVER.com

The technical information in this brochure corresponds to our present state of knowledge and experience at the date of printing (see imprint). No legal guarantee can be given, unless it has been explicitly agreed. The state of experience and knowledge is developing continuously. Please ensure that you always use the latest edition of this information. The described product applications do not take special circumstances in consideration. Please verify whether our products are appropriate for the specific application. For further information please contact our Isover sales offices. We deliver only according to our terms of trade and terms of delivery.

For further information and contact details, please visit our website at: www.isover-technical-insulation.com or contact your local ISOVER organization.